

## Testing/Commissioning

### Functionality of The Test Switch

- 1) A short press (>1s) on the button start a function test lasting 5 seconds (The battery's capacity should be more than 5% = charging 30mins)
- 2) Holding down the button(>10s) resets the timer(System-resets)

### Functional Test

The 5 second long, each 7 days' function test serves to check the functionality of the emergency unit, the batteries and LED module.

#### Notice :

-If a mains supply failure occurs whilst a functional test is in progress, the test shall be postponed and the system shall enter emergency operation. Following restoration of the mains supply, a postponed functional test shall re-commence automatically as soon as conditions permit.

### Duration Test (EN)

- Initial duration test: the test will be carried out exactly 24 hours later after the initial installation.
- Half year duration test: the test will be carried out on each 180-182 days.

#### Notice:

- A duration test shall only be started when the battery supply is fully charge if a mains supply failure occurs whilst a duration test is in progress, the test shall be postponed and the system shall enter emergency operation. Following restoration of the mains supply, a postponed duration test shall re-commence automatically when the battery supply is fully re-charge.
- The indicator will be slow flashing green within 5 days if the duration test be carried out success fully.

### Indicator LED

System status is locally by a bi-color indicator LED.

LED Indication	Status	Commentary
Permanent green	Standby, System OK	Mains operation, battery is charged
Fast flashing green (0.25s on–0.25s off)	Function test underway	Function test underway
Slow flashing green (1s on–1s off)	Duration test underway	Duration test underway
Permanent red	Lamp failure	Open circuit or short circuit or LED failure
Fast flashing red (0.25s on–0.25s off)	Battery capacity failure	Battery failed duration test
Slow flashing red (1s on–1s off)	Battery fault	Incorrect battery voltage or short circuit or open circuit
Green and red off	Battery operation	Emergency mode: mains disconnected or mains failure

#### Notice:

**Fault status:** if an error is detected, the indicator LED switches to red. if the error has been corrected please re-connecting the battery after the mains power off, the indicator LED immediately switches back to green when mains power on.

**Battery failed duration test:** after an exchange of the battery and holding down the button (>10s) reset the timer, the indicator LED switches to green.

V3 08/07/2022

**UK Manufacturer:** BH17 7BY

**EU Manufacturer:** Brilliant AG,  
Brilliantstrasse 1, D-27442 Gnarrenburg

saxby  
lighting

Instruction manual

# Emergency LED Conversion Kit

SAX01-92514



Thank you for purchasing this accessory. Please read the instructions carefully before use to ensure safe and satisfactory operation of this product. Please retain these instructions for future reference.

## Description

The unit is universal design for use with most LED lamps that works with constant power drivers. It is an emergency battery pack that uses electronic circuitry to convert energy stored in a battery into the DC voltage and current necessary to drive the LED load.

When in emergency mode, the unit will operate a 2.5W LED load with constant power with a rated output voltage of 10V-90V. The unit has a discharge protection circuit, over load, short circuit and battery low voltage protection.

Each unit includes the battery pack, LED charge indicator, a test switch and the emergency power module, everything combined in a single box.

## Important Notes

The unit use mains voltage, it should be installed by qualified electricians only according to European safety standard or relevant nation regulations.

The emergency converter can only be used with the LED lamps and only suitable for use in indoors. Protect the electronics converter against excessive heat.

Connect the LED lamps to the emergency converter with correct polarity according to the schematic drawing.

The maximum length of the output cable to the LED lamps should not exceed 3m according to the EMC standard.

Connect the unit to AC power only after the wiring been completed between emergency converter and LED lamps.

About such situations, no ability can be taken over for possible damage: the emergency converter is used for purposes other than originally intended, connected in the wrong way.

Battery should be charged once in three mouths in order to keeping it in initial performance.

The emergency function test must be performed when a battery is fully charged for 16 hours.

www.saxbylighting.com

saxby  
lighting

## Wiring Instructions

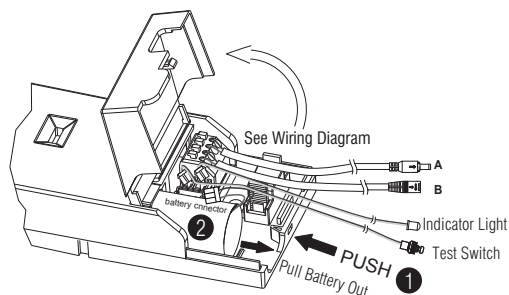

Note that the switch is turned off before installation.

- Push the cover at the right end to open first.
- Push the connector of Battery/Test Switch/Indicator Light into the Driver. The cables A & B supplied should already be fitted. And could be able to swap the position according to the wire required of your existing lights.
- Push the cover at the left end to open. Depress button and insert cables. Release button to secure cables.

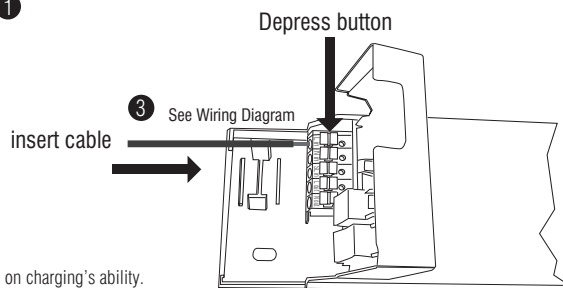

### Battery replacement steps:

- Open the top cover first
- Take off the battery
- Setup the battery
- Close up the cover

\* The battery should be changed when the battery be failed on charging's ability.

\* The battery is replaceable.

\* Building insulation may abut the sides of the LED module.

## Wiring Details For Saxby Products

The cables A & B should be able to swap the position according to the Wiring required for your existing lights, Wiring details of correct for using as below:

- For products as below, the cables will be fitted as per Diagram 1.

Sirio frame: 78546;

Stratus : 81023, 81024, 81025, 81026, 92270,  
92272, 92273, 92274, 92543, 92276,  
92277, 92542;

Axial : 78537, 78538, 78540, 78542.

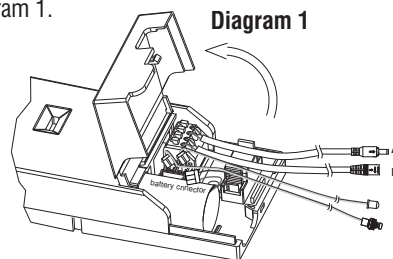

- For products as below, the cables will be fitted as per Diagram 2.

OrbitalPlus: 69880, 69881, 69882, 69883,  
69884, 69885;

OrbitalPro : 71512, 71515, 90954.

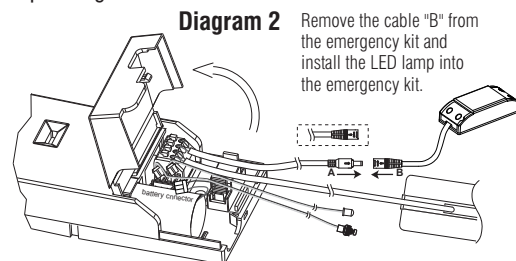

## Wiring Diagram

The output current of LED driver is under 1.5A.  
220-240V / 50-60HZ

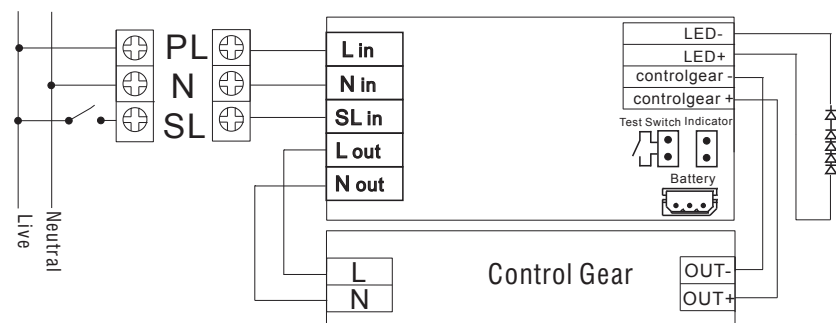

With the following cases, the indicator will be off

- Mains power off, the light goes into emergency mode.
- Battery is disconnect when mains power on.
- Battery be connected again after disconnected when mains power on (Attention: In that case, please re-connect the battery when mains power off, and then re-set the AC mains power).

## Technical Data

Rated supply voltage	220-24VAC
Mains frequency	50/60Hz
Mains input current	25mA-38mA
Mains Input power	3.5W ± 10%-4W ± 10%
Power factor	0.75C
Battery charge current	200mA
Battery warranty	2 years
EM LED current	13-185mA
EM LED current	13-185mA
EM LED voltage	10-90VDC
EM LED power	2.5W
EM LED emergency time	3h
Ambient temperature $t_a$	0... +45°C
Max. casing temperature $t_c$	+60°C
Battery type	LiFePO4 6.4V 1500mAh
IP rating	IP20
Dimensions (L x W x H)	199 x 55.2 x 24.5
Cut-out Dia	60mm

## Dimensions

unit:mm

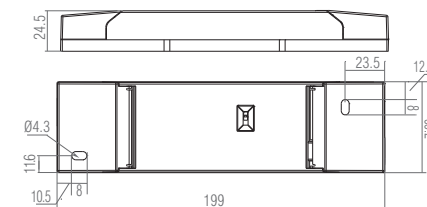

### Status Indication LED

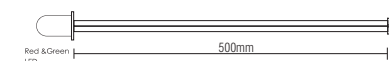

### Test Button

